

製品名 L型擁壁

参考質量

呼び名 H=750

428 kg

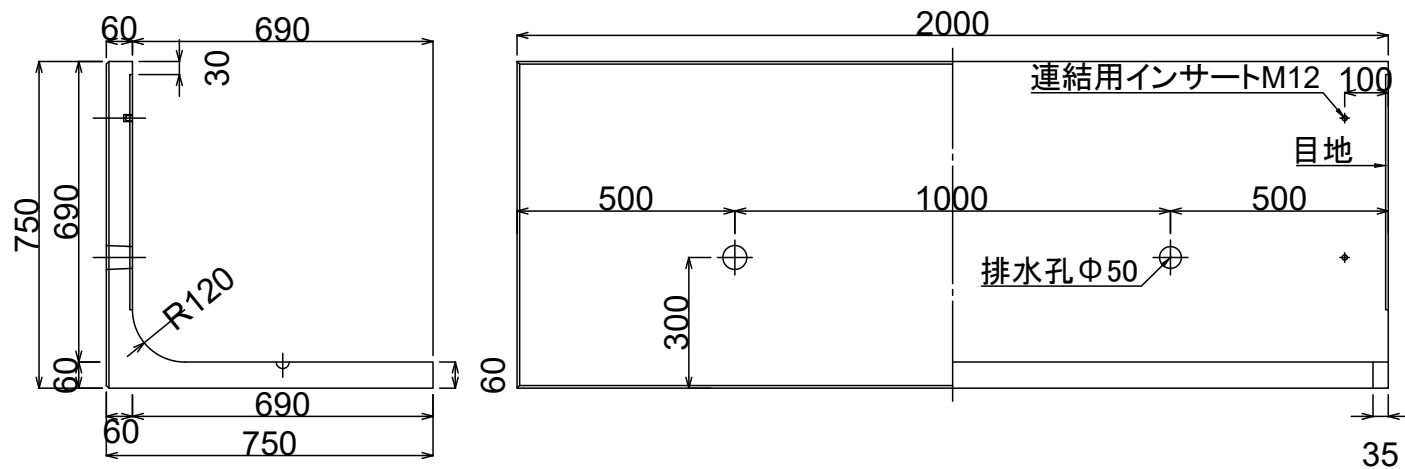

連結部詳細図

